

Varenummer: 40600801382470

Beskrivelse: Tandhjulsgeær C802F-13,8-P225B5

Mål

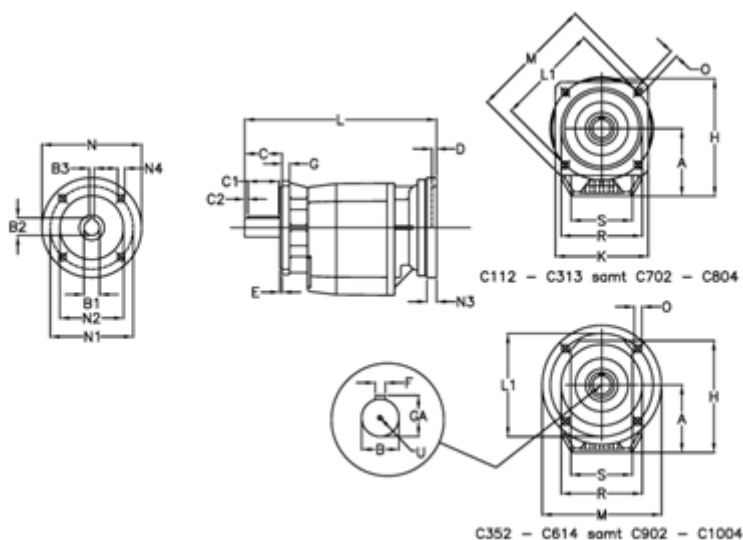

A = 247.0	D = 6.0	L1 = 350	R = 320
B = 80	E = 5	M = 400	S = 300
B1 = 60	F = 22	N = 450	U = M20x42
B2 = 64.4	G = 20	N1 = 400	
B3 = 18	GA = 85.0	N2 = 350	
C = 140	H = 422.0	N3 = 25	
C1 = 110	K = 350	N4 = 18	
C2 = 15	L = 705.5	O = 18.0	